

# Izar AC Charger User Manual

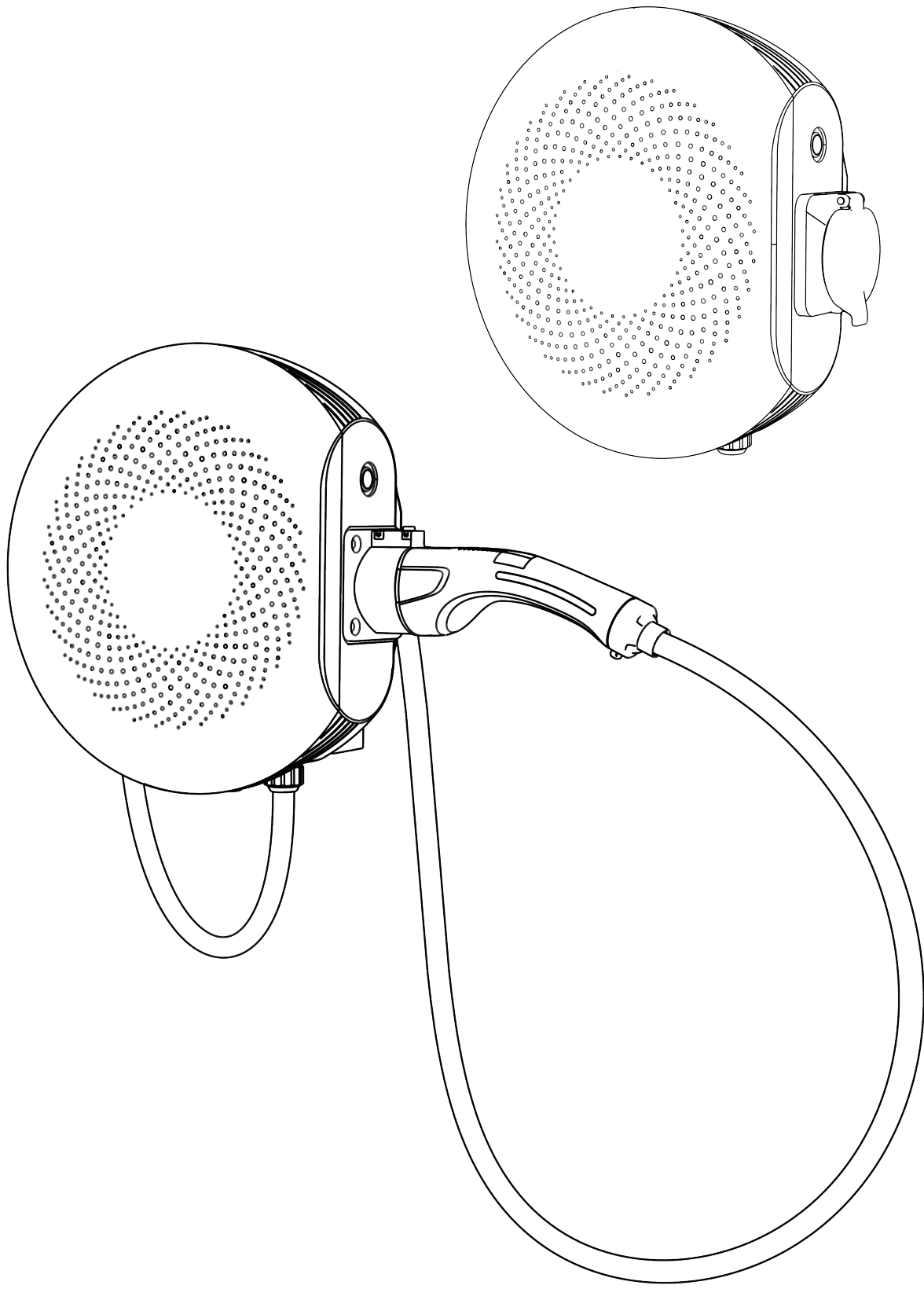

# Contents

---

## User Manual

About the document	2
1.Liability statement and disclaimer	3
1.1 Liability statement	3
1.2 Disclaimer	3
2.Safety Instructions	5
2.1 Symbol Conventions	5
2.2 Instructions for equipment use	6
2.3 Instructions for safe operation	6
3.Product overview	8
3.1 Brief introduction	8
3.2 Nameplate	8
3.3 Product use	9
3.4 Product naming overview	9
3.5 Product image	10
3.6 Product specifications	11
4.Sinexcel AC APP	13
4.1 Download APP	13
For Apple users, please search for Sinexcel AC in the Apple App Store to download and install it. For Android users, please search for Sinexcel AC in the Google App Store to download and install it.	
4.2 Registration/login	13
4.3 Binding	13
4.4 Unbind	14
4.5 Setting charging start time	14
4.6 Authorization management	15
4.7 Configuration setting	15
4.8 Firmware upgrade	16
5.Charging instructions	17
5.1 Charging steps	17
5.2 Indicator status	21
5.3 Cable management	23
5.4 Installation mode for disabled	24
6.Fault diagnosis and resolution	25
7.Network security	27
7.1 Warning	27
7.2 Product network security disclaimer	27
8.Warranty	28
8.1 Warranty period	28
8.2 Warranty conditions	28

---

# About the document

1.This manual is specifically for the Izar AC charger series products, providing comprehensive guidance for users of new energy vehicles users to use and maintain this charging equipment.

2.This manual will provide detailed product information and operating instructions for users. Users should read the contents of the manual carefully before use this product and ensure that you understand all the instructions. Please store this manual in a safe place for easy installation, operation, and maintenance personnel to obtain and use.

3.Without written authorization, it is forbidden to disclose, excerpt and copy part or all of the contents of this manual (including materials and publications).

4.The contents of this manual will be adjusted, revised and updated according to product upgrades. Users refer to the actual product purchased.

# 1. Liability statement and disclaimer

## 1.1 Liability statement

Requirements of users and field operators :

- Please operate charging stations with adequate safeguards in place and ensure that safeguards are properly installed and regularly maintained.
- Please prepare an emergency plan that instructs people on what to do in an emergency.
- Please prepare the installation site of the charging pile, according to the requirements described in this manual.
- Please ensure that the charger has enough space for installation and maintenance.
- It is necessary to be fully aware that changes and changes without permission may affect the user's operation authorization and may also affect the quality assurance.

## 1.2 Disclaimer

The product equipment needs to be used normally within a certain range of conditions. We will not be responsible for any accident or damage caused by one of the following conditions :

- Products and components which are not marked by our company ;
- Product or component which has exceeded our warranty period ;
- Faults and damages caused by not using in accordance with the instructions or using in an environment not in accordance with the instructions (for example, the temperature is too high, too low, too humid or dry, the altitude is too high, the voltage or current is unstable, etc.);
- Failure or damage caused by disassembly, repair, modification of products without the consent of our company, which is not installed, repaired, changed or disassembled by our after-sales service personnel;
- Normal use of old, wear and tear, breakage and immersion, etc.
- Failure or damage caused by accident or human causes (operation error, scratch, handling, knock, access to inappropriate voltage, etc.), transportation damage ;
- Failure or damage caused by force majeure such as natural disasters (such as earthquake, lightning strike, fire, abnormal voltage, etc.);



1. Without the permission of our company, users are strictly prohibited from modifying the parameters by themselves. Other unpredictable faults caused by the user modifying the parameters without authorization will be solved by the user himself.







2. It is forbidden to use any other adaptors to charge an electric vehicle that does not comply with the standards of this product! If the user does not comply with the warnings in this manual, the user will be responsible for any risks from the use of the adaptor!

3. It is forbidden to extend the cable of the connector without permission! If the user does not comply with the warnings in this manual and extends the cable of the connector, any risks will be borne by the user!

---

## 2. Safety Instructions

### 2.1 Symbol Conventions

Identification	Description
	Warning Indicates a potentially hazardous situation which, if not avoided, could result in death or serious injury.
	Danger Caution electricity
	Caution of fire
	Note A note gives more details to make easily use.
	It means that the machine cannot be discarded after use and should be delivered to a dedicated recycling place, otherwise it may cause environmental pollution.
	Grounding identification This indicates that the product must be grounded during installation. If it is not properly grounded, it may cause death or serious injury

## 2.2 Instructions for equipment use

- This product is an all-in-one machine that can charge electric vehicles in indoor and outdoor areas.
- Please use and save the product information and accessories provided with the equipment from the factory.
- If the user has any problems or failures during use, please consult the equipment provider directly. During the warranty period, if you find a third party or non-professionals for maintenance without authorization, the user will be responsible for any safety consequences.
- The installation environment of charging equipment should be far away from fire and other dangerous sources.

## 2.3 Instructions for safe operation

Please read the product manual carefully before use, and strictly follow the steps in the product manual.

- Without the permission of the manufacturer, users are strictly prohibited from disassembling and other improper operations on this product, and the adverse consequences caused by improper operations shall be borne by the users themselves.
- It is strictly forbidden to touch the charging plug or the charging socket of the electric vehicle, keep the charging plug in a dry state, and do not touch the charging plug with wet hands.
- It is strictly forbidden to continue to use the charging device when the charging head is damaged or the insulation skin is damaged.
- Make sure that no foreign objects remain in the charging plug and the charging socket on the vehicle side.
- Properly lock doors after installation or maintenance operations.

Do not use the charger in the following situations and contact the manufacturer immediately:

- Outer shell damage

Electric vehicle charging cable or charging gun damage

- Lightning strikes the charger
- Accident or fire near the charger
- Water has entered the charger



Warning: If an emergency occurs during the use of this product, please press the emergency stop button immediately, it is strictly forbidden to use the emergency stop button in non-emergency situations! After pressing it, do not reset the emergency stop switch by yourself, you should immediately notify the professional to reset the emergency stop switch operation, if you do not comply with the requirements of this manual to reset the emergency stop switch by yourself, any risks will be borne by the user!

---

















## 3.Product overview

### 3.1 Brief introduction

Izar is an AC charger for electric vehicles. It is mainly composed of a charger body and an optional pedestal, including Socket and Cable version. The IP grade of the Socket version is IP55, and the IP grade of the Cable version is IP65. Izar has multiple security protections to ensure the smooth operation of the equipment.

### 3.2 Nameplate

<b>Izar</b>	
<b>EV AC Charger</b>	
<b>Model: SEA230/32I-E-S</b>	
<b>Input rated voltage: 230Vac</b>	
<b>Input rated current: 32A</b>	
<b>Frequency: 50Hz</b>	
<b>Input System: 1L+N+PE</b>	
<b>IΔn DC: 6mA</b>	
<b>Output rated Power: 7.4kW</b>	
<b>Operating temperature : -30~50°C</b>	
<b>IP Degree: IP55</b>	
<b>SN: SH0C667255742305090001</b>	
<b>Date Of Production: 2023.5.9</b>	
<b>Shenzhen Sinexcel Electric Co.,Ltd.</b> Building 6,Baiwangxin High-tech Industrial Park, Nanshan District,Shenzhen City,P.R.CHINA	
     	

<b>Izar</b>	
<b>EV AC Charger</b>	
<b>Model: SEA230/32I-E-C</b>	
<b>Input rated voltage: 230Vac</b>	
<b>Input rated current: 32A</b>	
<b>Frequency: 50Hz</b>	
<b>Input System: 1L+N+PE</b>	
<b>IΔn DC: 6mA</b>	
<b>Output rated Power: 7.4kW</b>	
<b>Operating temperature : -30~50°C</b>	
<b>IP Degree: IP65(Vehicle connector IP54)</b>	
<b>SN: SH0C667255732305090001</b>	
<b>Date Of Production: 2023.5.9</b>	
<b>Shenzhen Sinexcel Electric Co.,Ltd.</b> Building 6,Baiwangxin High-tech Industrial Park, Nanshan District,Shenzhen City,P.R.CHINA	
     	

### 3.3 Product use

Izar is used for AC charging of electric vehicles and is suitable for use in indoor or outdoor environments. Izar should only be used with accessories supplied by the manufacturer or in compliance with local standard specifications.

### 3.4 Product naming overview

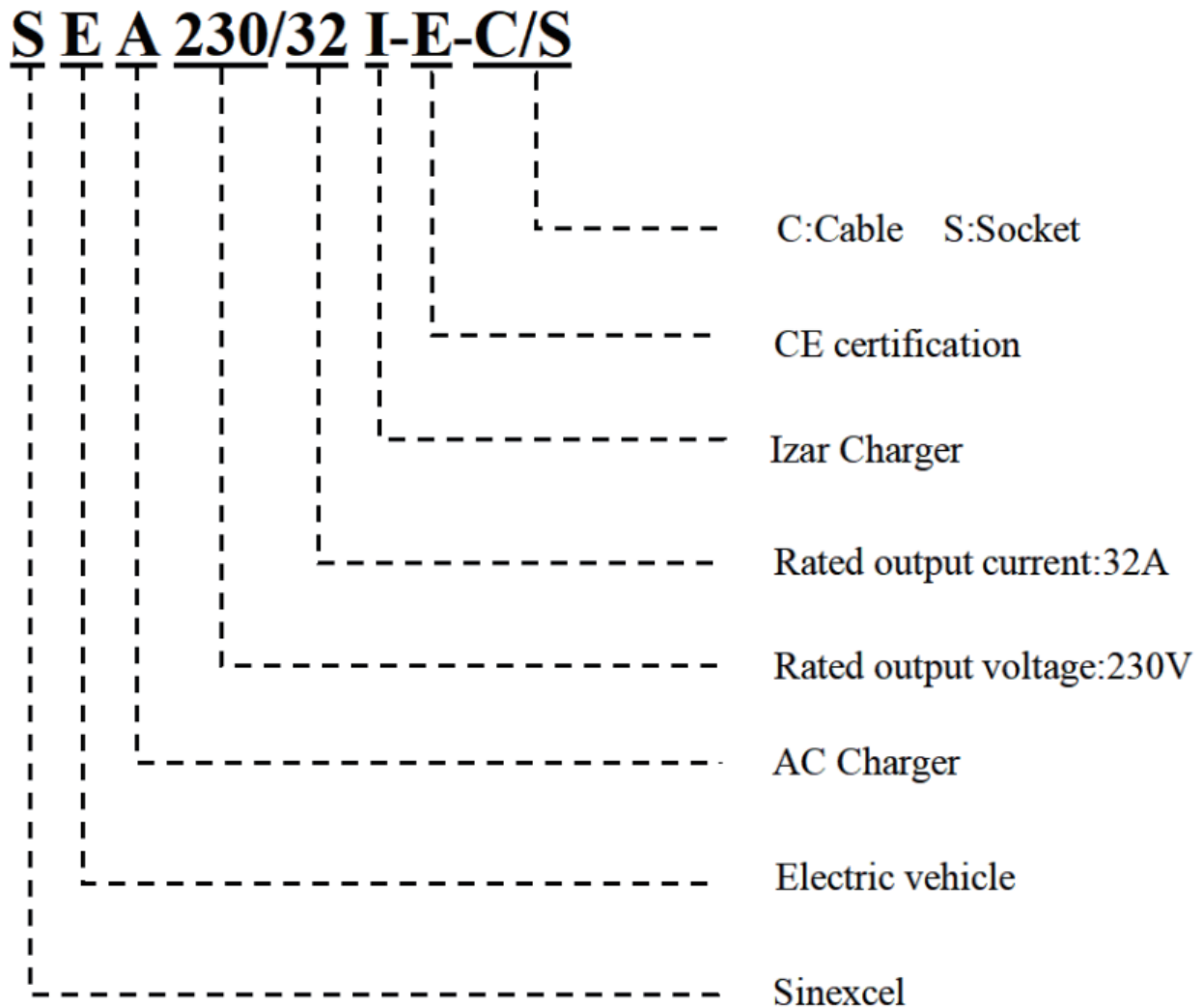

### 3.5 Product image

- 
- |                          |                     |                       |
|--------------------------|---------------------|-----------------------|
| 1. Emergency stop button | 2. Socket           | 3. Card swiping area  |
| 4. LED                   | 5. Connector holder | 6. Charging connector |
- 



No	Name	Functions
1	Emergency stop button	Emergency press to stop charging immediately
2	Socket	Connect connector wire
3	Card swiping area	RFID card identification area (optional)
4	LED	Display charging and standby status
5	Connector holder	Fix charging connector
6	Charging connector	Connect to the car



**Tips:** The emergency stop button is not a power-off restart button. It is forbidden to press it in non-emergency situations. The charger will stop charging immediately after pressing it. If the emergency stop button is pressed by mistake, please press it again to reset it.



Note: Izar Socket and Izar Cable have the same shell size.

### 3.6 Product specifications

European standard AC charger ( residential ) Izar		
Type	SEA 230/32I-E-S	SEA 230/32I-E-C
Product name	Izar Socket	Izar Cable
Rated power	7.4kW	7.4kW
Basic Specifications		
Input/output current	32A	
Input/output voltage	Single phase 230V (±10%)	
Demensions	L336*W299*D120mm	
Weight	2.7KG	3.8KG
Frequency	50/60Hz	
Standby power consumption	≤5W	
Connectortype	IEC Type 2	
Charging cable	/	Length: 3m (5m,7m for optional)
Charging method	Plug and Charge, RFID, APP	
Emergency stop function	Yes	
RCD	DC 6mA + Type A(optional)	
Charging status	LED	
Meter	Onboard Metering Capabilities (Class B)	
Communication method	Bluetooth, WiFi, 4G (optional)	
Working temprature	-30℃—+50℃	
Relative Humidity	5%—95%	
Operation Altitude	<2000m	
Installation	Floor-mounted/Wall-mounted	
Protection rating	IP55/IK10	IP65/IK10
Protection	overcurrent protection, overvoltage/undervoltage protection, lightning protection, short circuit protection, ground fault protection, etc.	

Recoverable failure	emergency stop, input overvoltage and undervoltage, grounding, connector lock abnormality, overfrequency and underfrequency fault, restart charging after recovery, onboard metering abnormality, CT abnormality (optional)
EMC	Class B (Residential environment)
Support power system	TN-CS, TN-C, TN-S, TT
Certification	CE, TUV mark, TR25, RCM, UKCA
Color	Snow white
Noise	≤15dB

## 4.Sinexcel AC APP

### 4.1 Download APP

For Apple users, please search for Sinexcel AC in the Apple App Store to download and install it. For Android users, please search for Sinexcel AC in the Google App Store to download and install it.

### 4.2 Registration/login

You need to complete the registration for the first time log in to the Sinexcel App, before enter the APP interface.

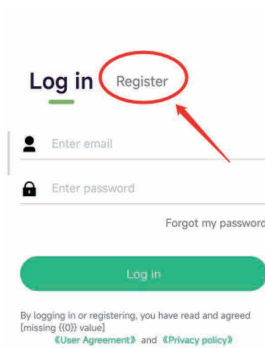

### 4.3 Binding

As shown in the picture, enter the App interface, click "+" in the upper right corner to enter the binding page. Enter a custom name, click on the charger model to select Izar; the charger number is bound by scanning the code, the charger number is automatically obtained by scanning the specified QR code. Click "Bind now". During the process, the location permission needs to be enabled. A Charger can be only bind to one account, and one account can be bound to multiple chargers.



## 4.4 Unbind

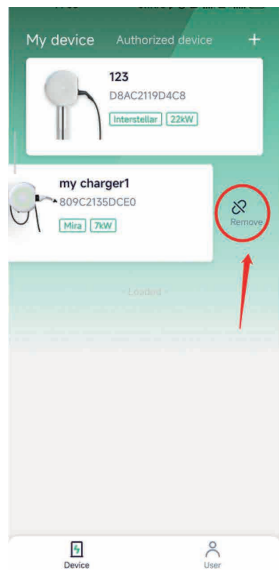

## 4.5 Setting charging start time

On the "Device Details" page, click "Scheduled Charging", and click the "Start Scheduled Charging" button to start the scheduled charging function. When the time reaches the set time point and the gun is inserted, the pile will automatically start charging. Click the "Cancel Scheduled Charging" button to cancel the scheduled start charging function.

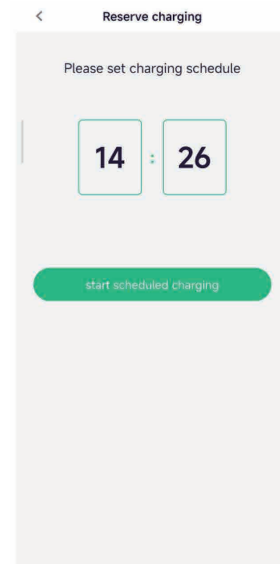

## 4.6 Authorization management

Click "Authorization Management" in the "Device Details" interface, click "Add Authorization" in the upper right corner, enter the email account of the authorized user (already registered), and click "Save and Apply" to complete the authorization. the authorized user can only use start and stop Charging, regular charging, plug-and-charge, and some functions of data analysis, but not other functions.

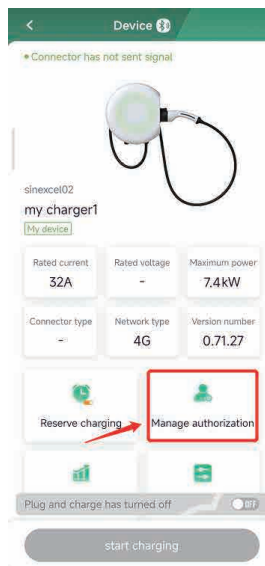

## 4.7 Configuration setting

Click "configuration Settings" in the "Device Details" interface, and you can view or set the following parameters in this interface. (Note: Users must not modify parameters without authorization to avoid unnecessary trouble).

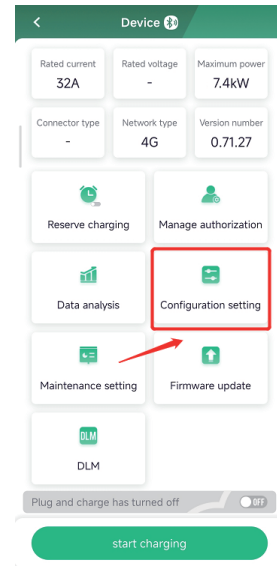



## 4.8 Firmware upgrade

Click "Firmware Upgrade" in the "Device Details" interface to enter the "Firmware Upgrade" interface. Select the version, upgrade or downgrade to the corresponding version of the software, and click Upgrade or Downgrade, according to the needs.

When the software is being upgraded, please wait patiently for the upgrade progress bar to complete, which is expected to take 2-3 minutes.

After the upgrade is complete, the pile will automatically restart.

After restart, the APP needs to reconnect to the charger. Please check the device version under the "Device Details" interface to confirm whether the upgrade is successful.

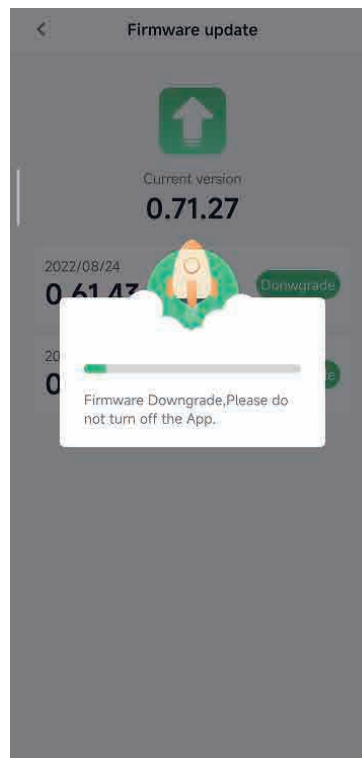

# 5. Charging instructions

## 5.1 Charging steps

### 5.1.1 Charge with APP

#### Step 1: Insert the connector

Insert the connector into the socket of the electric vehicle, and the indicator light changes from green to blue.

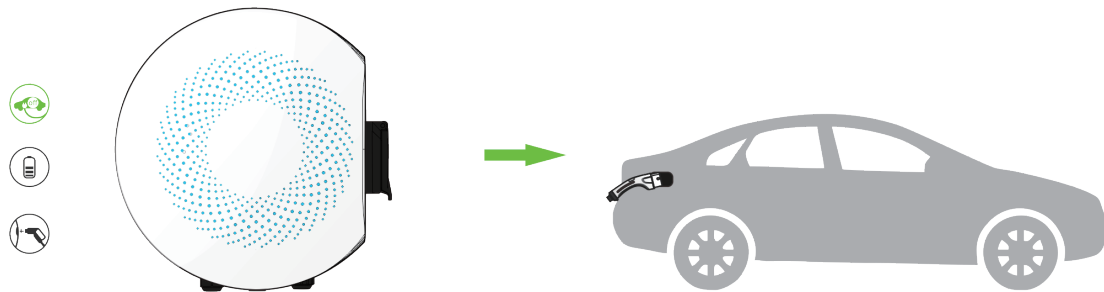

#### Step 2: Start charging

After opening the APP and connecting the charger, click "Start charging" in the device details interface, and the indicator turns blue, then the charging will be successfully started. (To use the APP for the first time, you need to register an account. Please refer to 4.3 Binding).

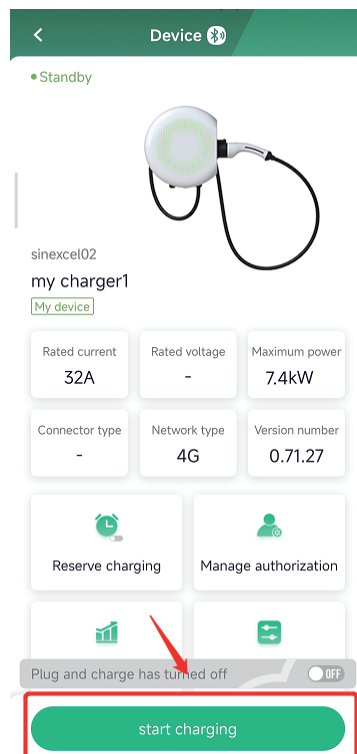

### Step 3: Stop charging

When the battery is fully charged or click "Stop charging" on the device details interface of the APP, the indicator light will turn blue and stay on, and the battery will stop charging. Pull out the connector and return it to the socket of the charger. The indicator light turns green and is always on, and it enters the standby state.

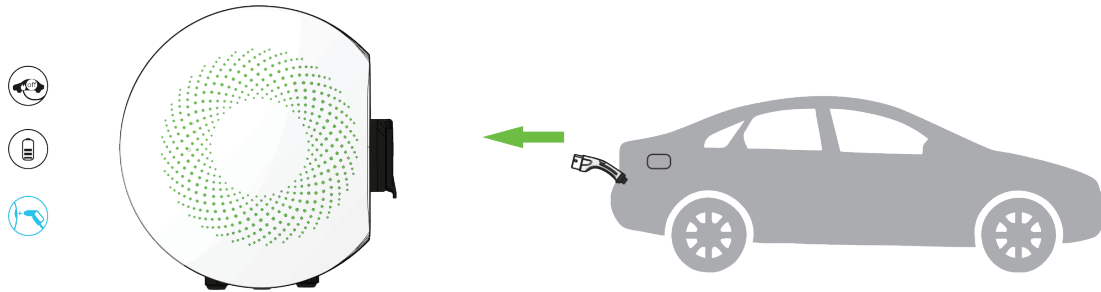

### 5.1.2 Charge with RFID card

#### Step 1: Insert the connector

Insert the connector into the socket of the electric vehicle, and the indicator light changes from green to blue.

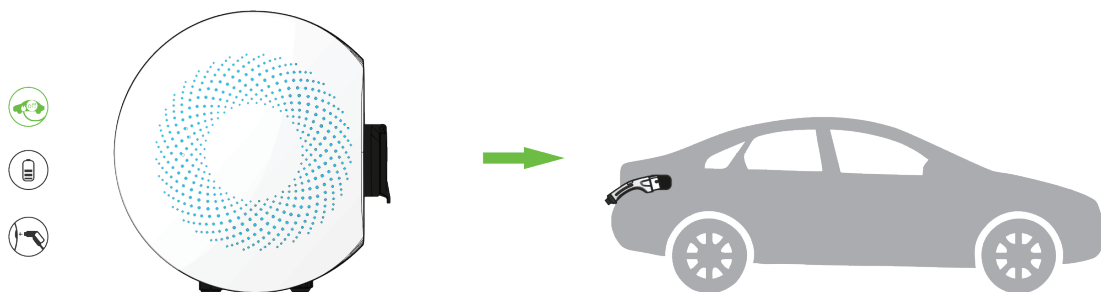

#### Step 2: Start charging

Place the RFID card in the card reading area. After the RFID card is successfully identified, the indicator turns to blue breathing light, and then the charging is successfully started.

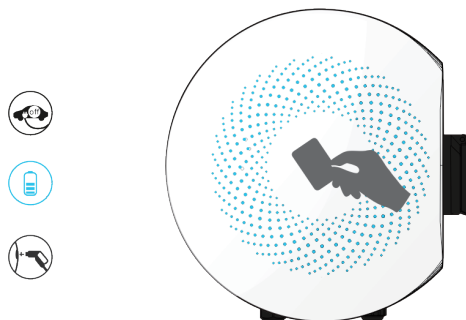

### Step 3: Stop charging

When the charge is fully charged or the card is swiped in the card reading area, the indicator light turns blue and stays on, and the charging is stopped. Pull out the connector and return it to the socket of the charger. The indicator light turns green, and it enters the standby state.

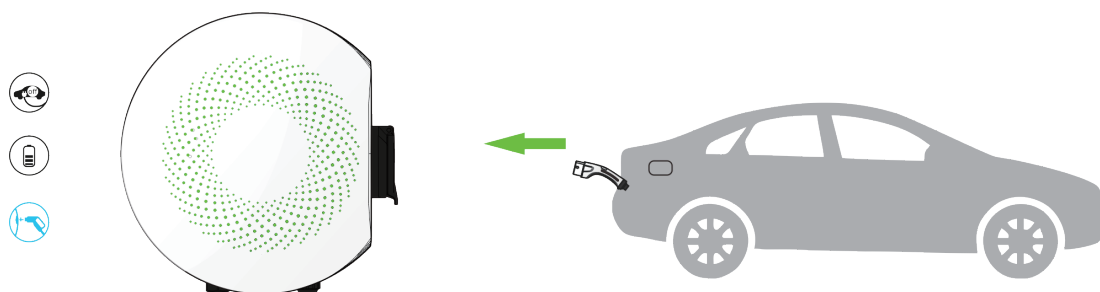

## 5.1.3 Plug and charge

### Step 1: Set the mode

After opening the APP and connecting the charger, click the "off" button of plug and charge in the device details interface to start the plug and charge mode.

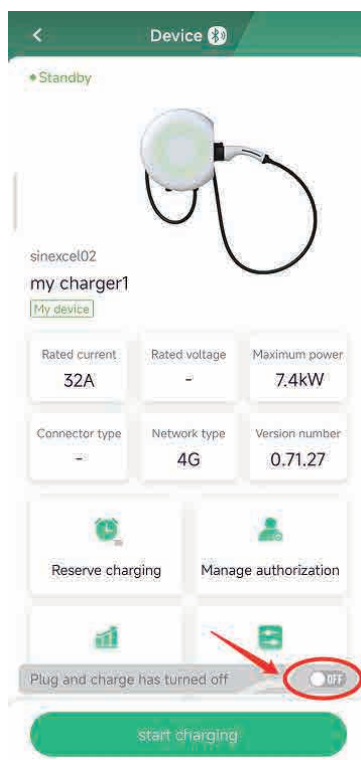

### Step 2: Insert the connector

Insert the charging connector into the connector of the electric vehicle, the indicator light will change from green to blue, and water will flow, and the connector will immediately enter the charging state.

### Step 3: Stop charging

When the charging is fully charged/swipe the card in the card reading area/click "Stop charging" in the APP interface, the indicator light will turn blue and stay on, and the charging will be stopped. Pull out the connector and return it to the socket of the charger. The indicator light turns green and is always on, and it enters the standby state.



Note: The emergency stop button is not a power-off restart button, and should not be pressed in non-emergency! After pressing it, it will immediately stop charging, and after pressing it, do not reset the emergency stop switch by yourself, you should immediately notify the professional to reset the emergency stop switch operation. If you do not comply with the requirements of this manual to reset the emergency stop switch by yourself, any risks will be borne by the user!

Note: Unplug the connector after each charging process, otherwise the charger cannot be used next time!

---

## 5.2 Indicator status

Charger status	Indicator status	
Standby	Green light is on	
Connect	Blue light is on	
Charge	Blue breathing light	
Emergency stop	Red light is on	

Note: the indicator light status of socket version and cable version AC charger is consistent

## Indicator status overview

State	Breathing light indication
Standby	Green light is on
Connect	Blue light is on
Charge	Blue breathing light
Emergency stop	Red light is on
Under/over voltage	Red light is on, blue flashes for 2s
RCD failure	Red flashes for 2s
Over current	Red flashes for 500ms
Relay adhesion	Red light is on, green flashes for 500ms
Meter fault	Red light is on, green flashes for 2s
Ground fault	Red light is on, blue flashes for 500ms
Network anomaly	Green light is on, blue flashes for 2s
Reader warning	Green flashes for 2s
USB data	Blue flashes for 2s. If fails, the light will be off. If succeeds, blue light will be on. Unplug the USB and will turn to green.
Buzzer	If the log is uploaded successfully, the buzzer will ring

Note: Fault diagnosis and resolution please refer to Section 6

## 5.3 Cable management

The cable management system solves the user's trouble in actual use, keeps the cable clean and tidy, and avoids touching the floor. After charging, the user can easily wrap the cable around the hook on the column for easy operation. As shown in the figure below.





## 5.4 Installation mode for disabled

In order to provide convenience for the disabled, the installation height of the charger can be adjusted so that the disabled can have a better product use experience, as shown in the figure below.

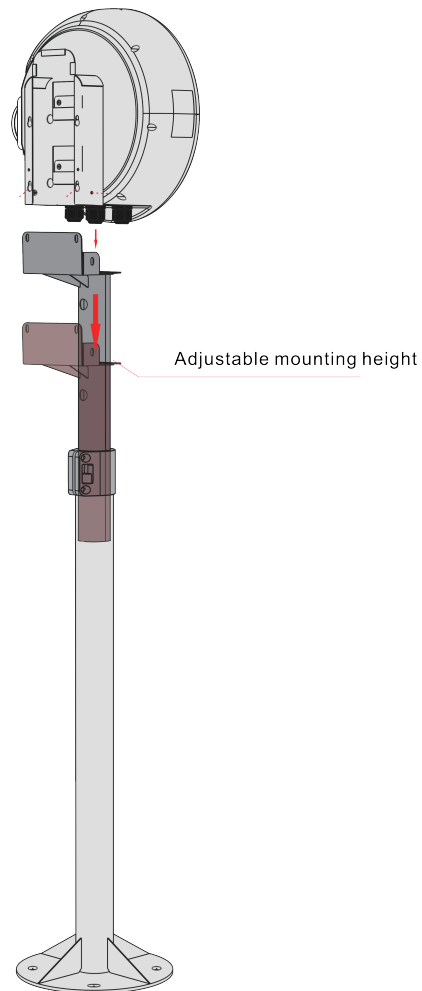

## 6、 Fault diagnosis and resolution

When the indicator light of the charger has the following fault light effect, the corresponding fault treatment method is as follows.

Error code	Error type	Description	Treatment method
Error 1	Emergency stop fault	Emergency stop button is pressed in case of emergency	<ol style="list-style-type: none"> <li>1. Check whether the emergency stop button is pressed, and if so, reset the emergency stop</li> <li>2. Power off and open the cover, check whether the emergency stop terminal is loose, and if so, plug it again</li> </ol>
Error 2	Overvoltage fault	Input voltage is greater than overvoltage (257V)	Use APP to check Whether the overvoltage value is smaller than the input voltage of the charger, and if so, reset the reasonable overvoltage value
Error 3	Undervoltage fault	The input voltage is less than the undervoltage value (183V)	<ol style="list-style-type: none"> <li>1. Use APP to check whether the undervoltage value is greater than the input voltage, and if so, reset the reasonable undervoltage value</li> <li>2. Use APP to check whether the type of meter is single-phase meter and whether the rated power is 7.4kW. If not, change it to single-phase meter and 7.4kW</li> </ol>

Error 4	Overcurrent fault	The output current is greater than the overcurrent value (35A)	Contact Technical Support
Error 6	Relay adhesion fault	The relay contact is overheated, causing adhesion or failure	Contact Technical Support
Error 7	Meter communication failure	Abnormal communication or fault of electric energy metering module	Contact Technical Support
Error 8	Card reader communication failure	The card reader is faulty or damaged	Contact Technical Support
Error 10	Leakage fault	The RDC leakage detection module fails or there is residual current in the charging circuit, and the current leaks to the ground	Contact Technical Support
Error 11	Ground fault	Charger is not grounded	Contact Technical Support

Note: If the above troubleshooting methods cannot solve the problem, please contact the technical support for help.

## 7. Network security

### 7.1 Warning

The security protocol mentioned in this manual must be used for connection. If the security protocol is not used, there will be network security risks.

### 7.2 Product network security disclaimer

The product is designed to connect with the network interface and transmit information and data through the network interface.

You are responsible for providing and continuously ensuring the secure connection between the product and your network or any other network, and developing and maintaining any appropriate measures (such as but not limited to installing firewall, authentication, encrypted data, anti-virus program, etc.) to protect the product, network, system and interface, and prevent any type of security vulnerability, unauthorized access, interference, intrusion, data or information disclosure and/or theft.

The manufacturer shall not be liable for any damage and/or loss caused by the above security vulnerabilities, any unauthorized access, interference, intrusion, data or information disclosure and/or theft.

Although the manufacturer provides functional tests for the released products and updates, you should develop your own test procedures for any product updates or other major system updates (including but not limited to code changes, configuration file changes, third-party software updates or patches, hardware changes, etc.) to ensure that the security measures you implement are not damaged.

## **8. Warranty**

### **8.1 Warranty period**

The warranty period of this product is subject to the contract. Our products are within the warranty period, and the customer should take the initiative to show the invoice, date and SN number of the purchased product to our service personnel during maintenance. At the same time, the nameplate on the product should be clearly visible, otherwise we have the right not to repair.

### **8.2 Warranty conditions**

The user has fully complied with the storage, installation and use rules stipulated in this manual and the product has quality problems.

When the user unpacks and inspects, finds that the product or components are damaged, and relevant personnel confirmed or kept the damaged parts and pictures.

For products that fail during the warranty period, our company will repair or replace the same type of products free of charge; the faulty machine after replacement shall belong to our company.

# Izar AC Charger User Manual